

# The Transformer architecture

Marco Kuhlmann

Department of Computer and Information Science

# Attention is all you need

- Recurrent neural networks implement a sequential model of computation that processes sequences element-by-element.
- In contrast, attention facilitates direct access to all elements, independently of sequence length.
- The **Transformer** is an encoder–decoder architecture that drops recurrent neural networks and exclusively uses attention.

can be parallelised

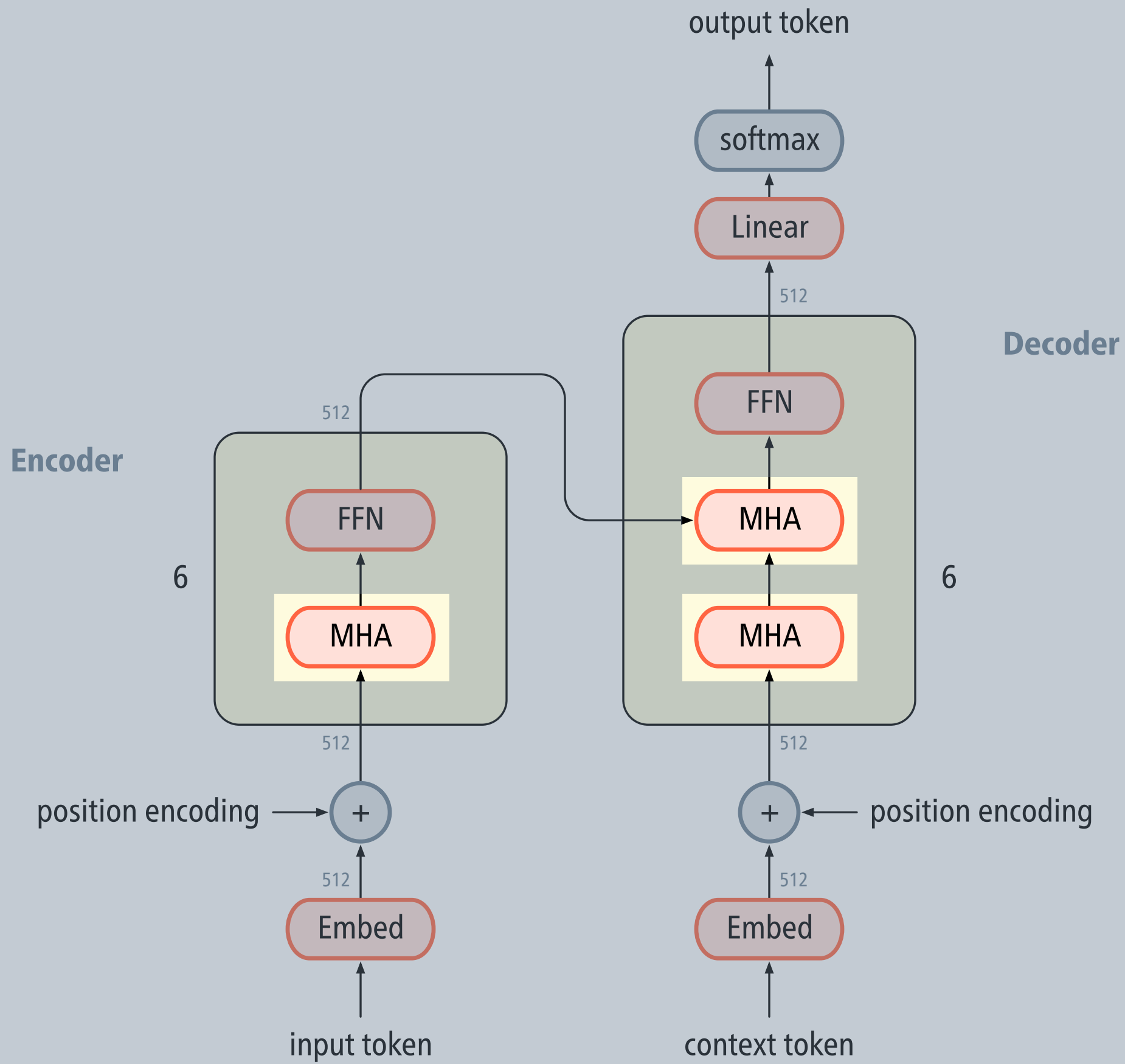

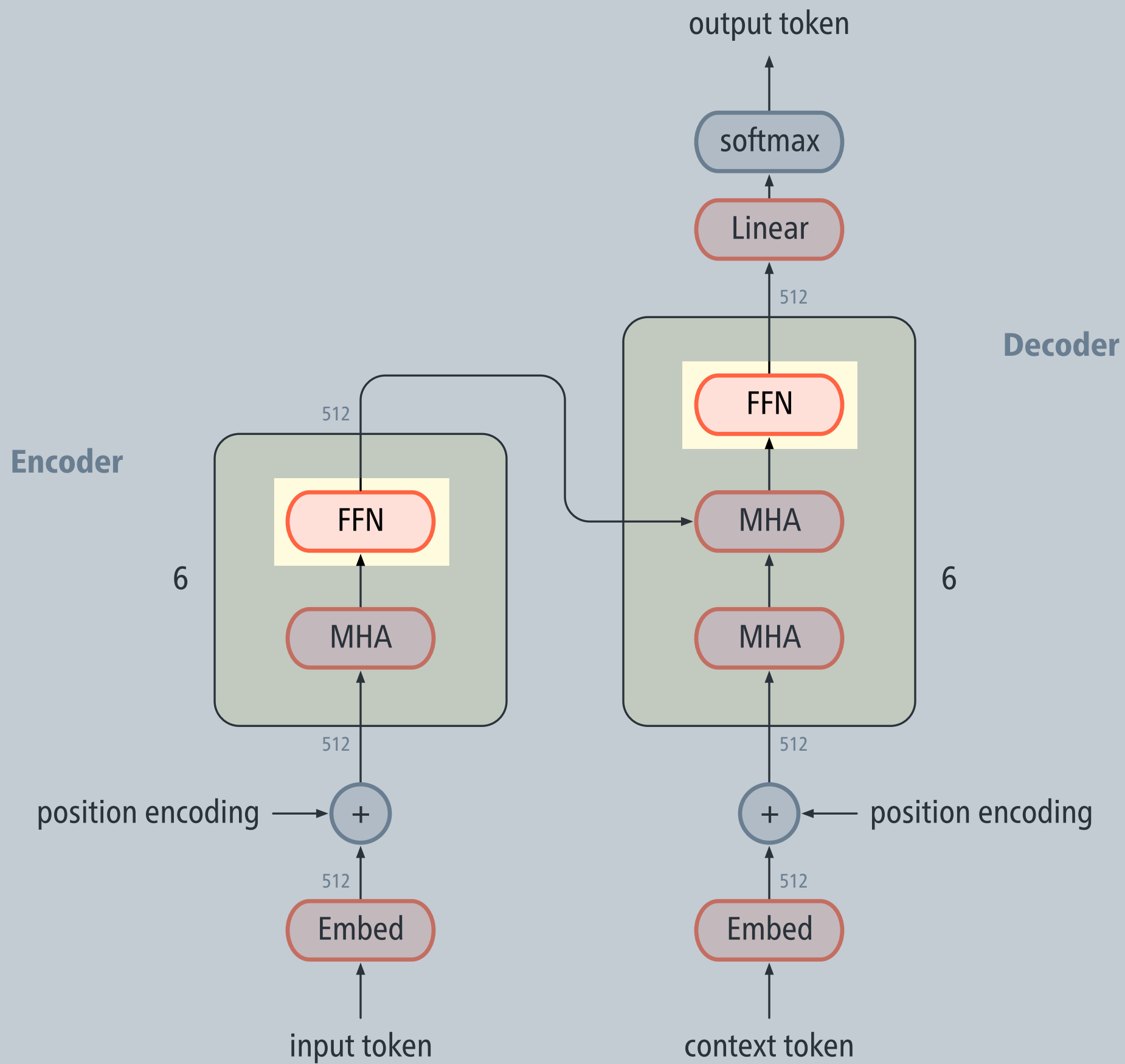

# Example translation

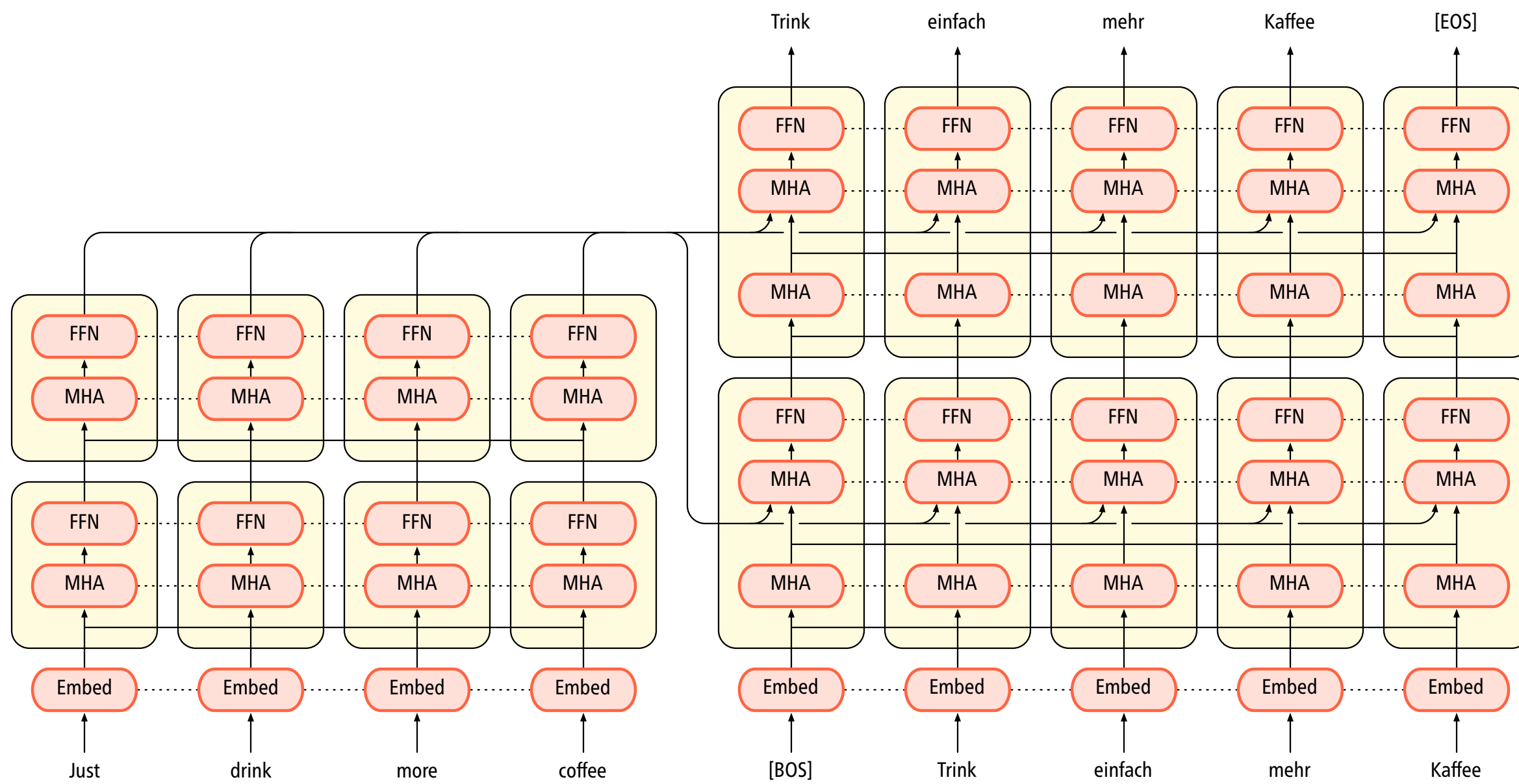

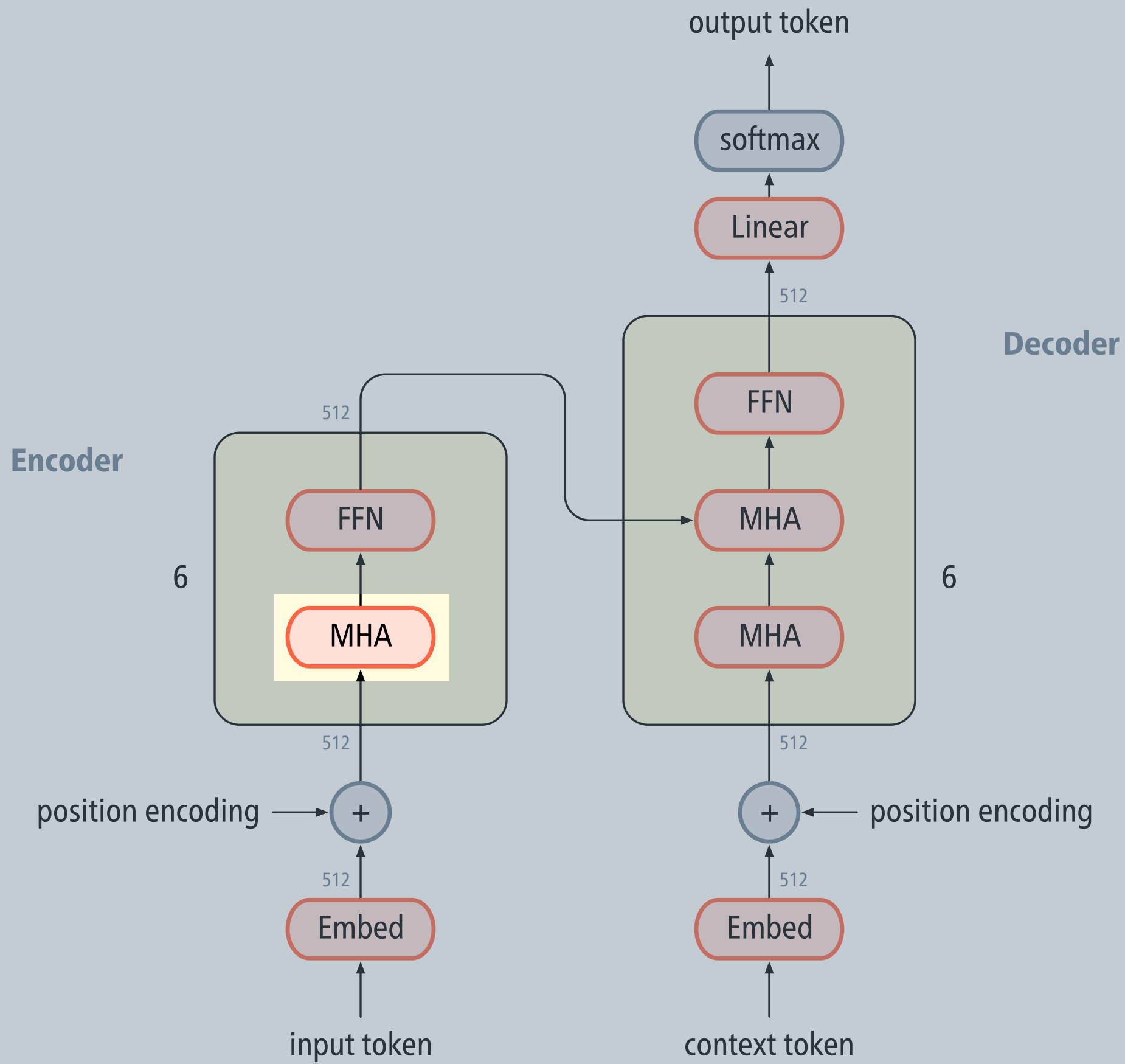

# Multi-head attention in the encoder

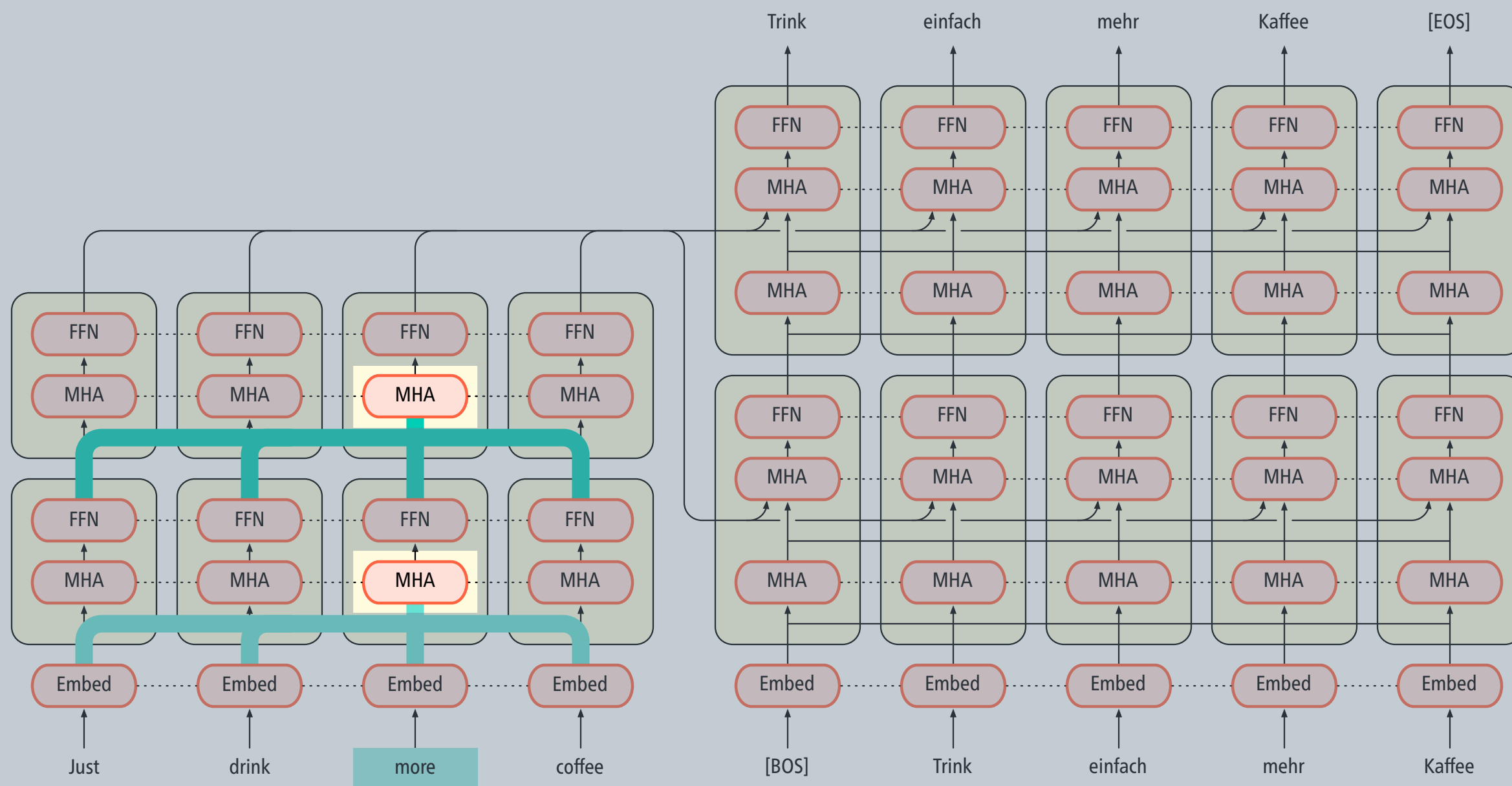

# Multi-head attention in the encoder

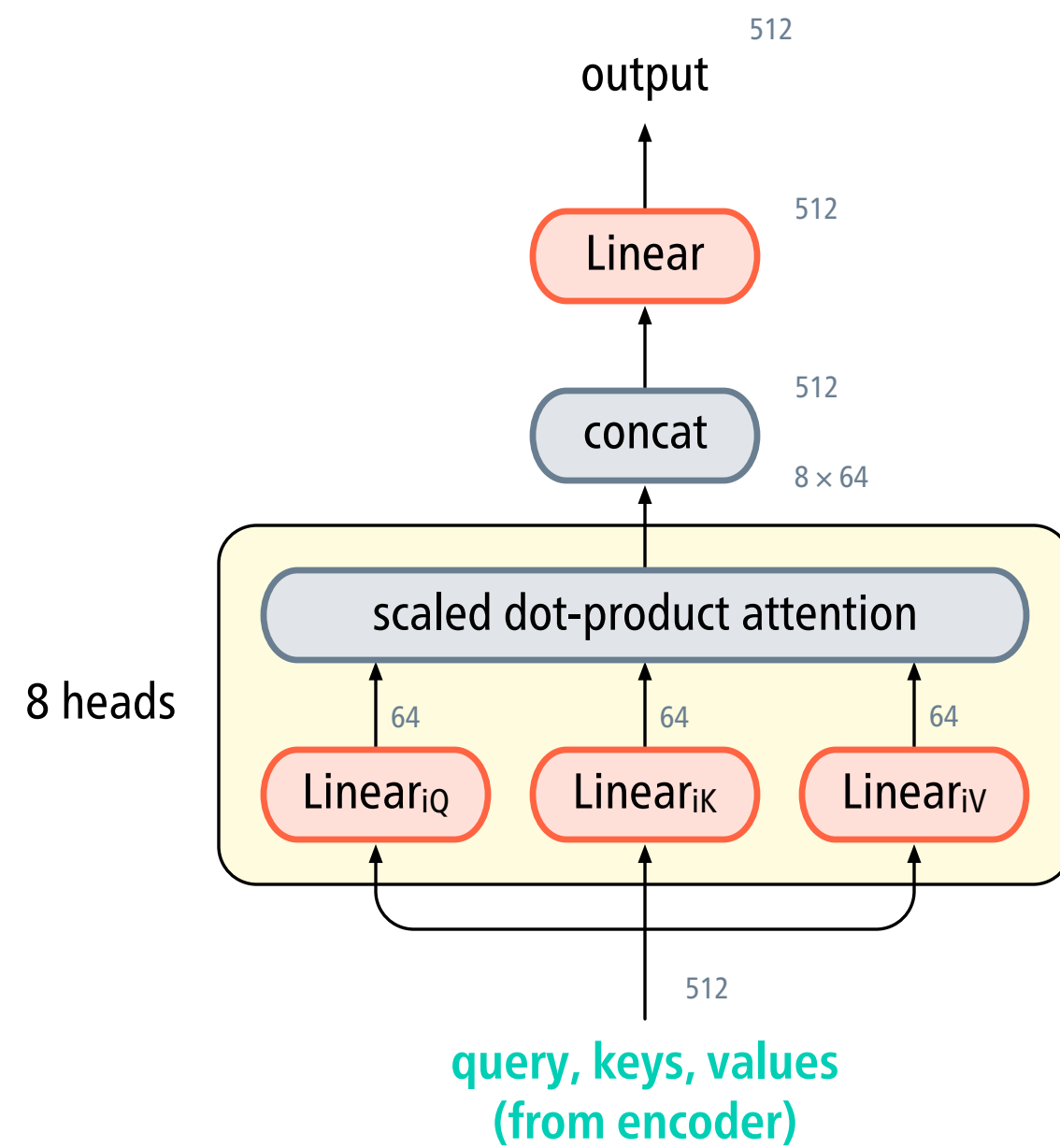



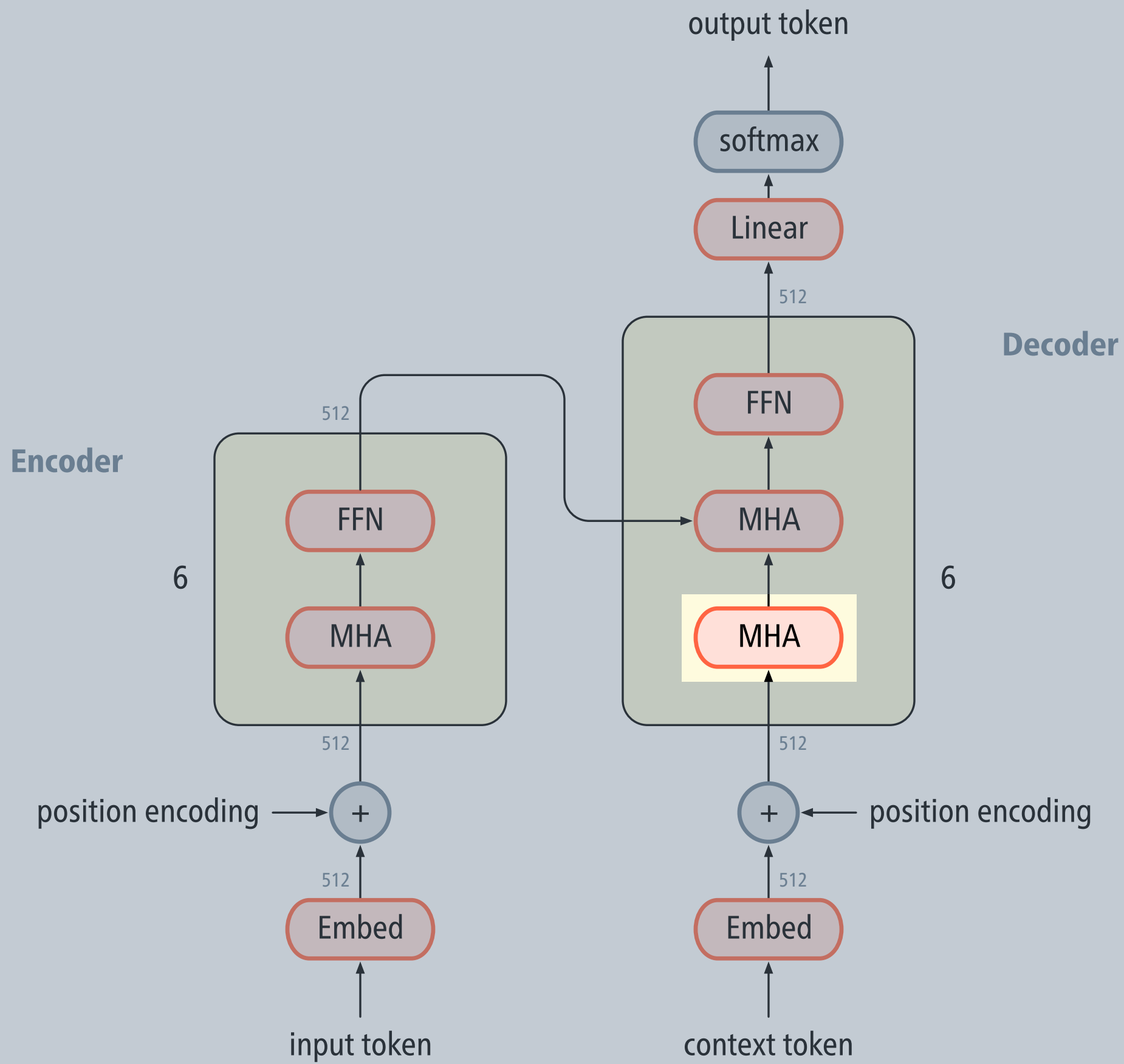

# Multi-head attention in the decoder

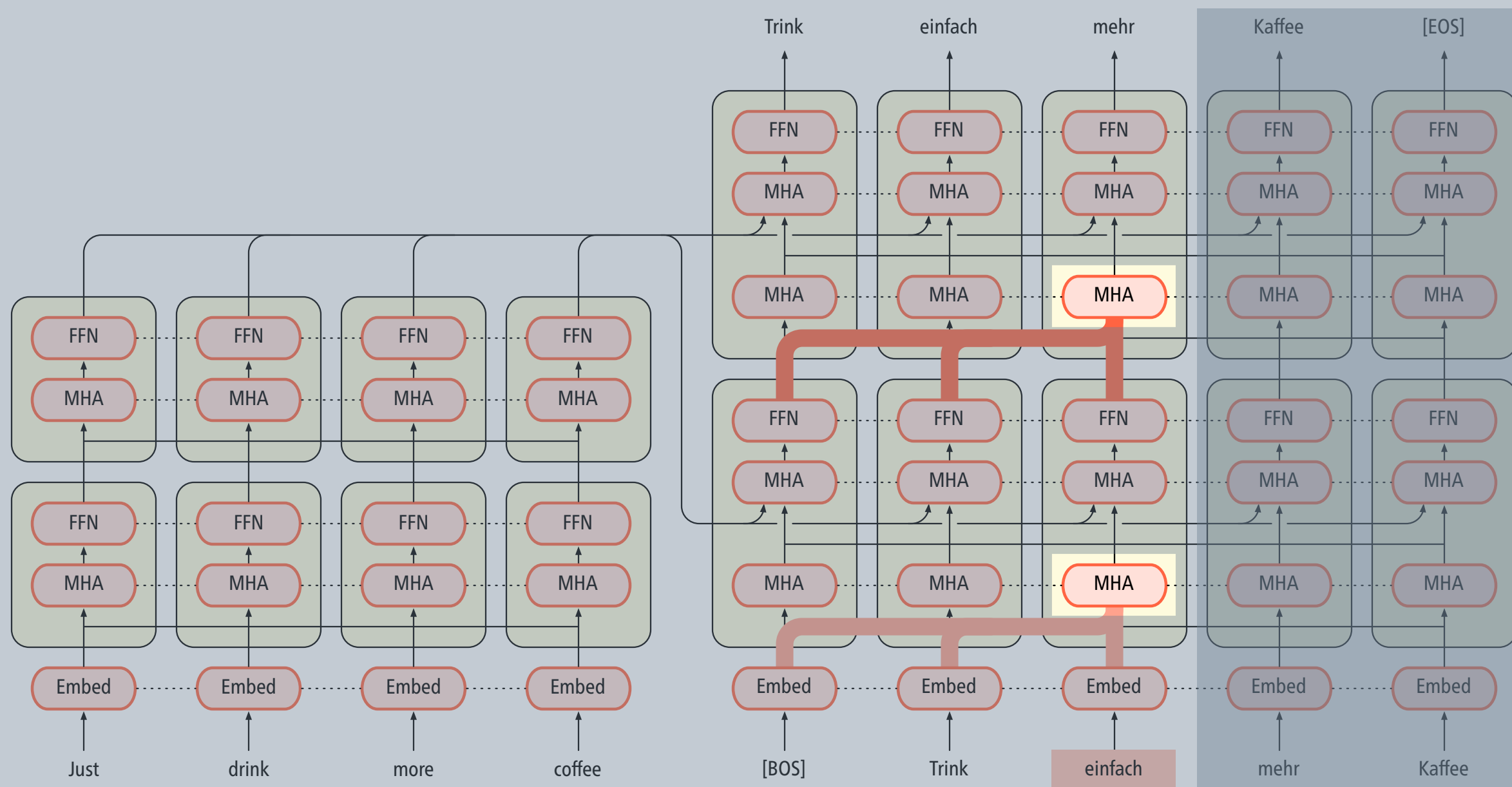

# Multi-head attention in the decoder

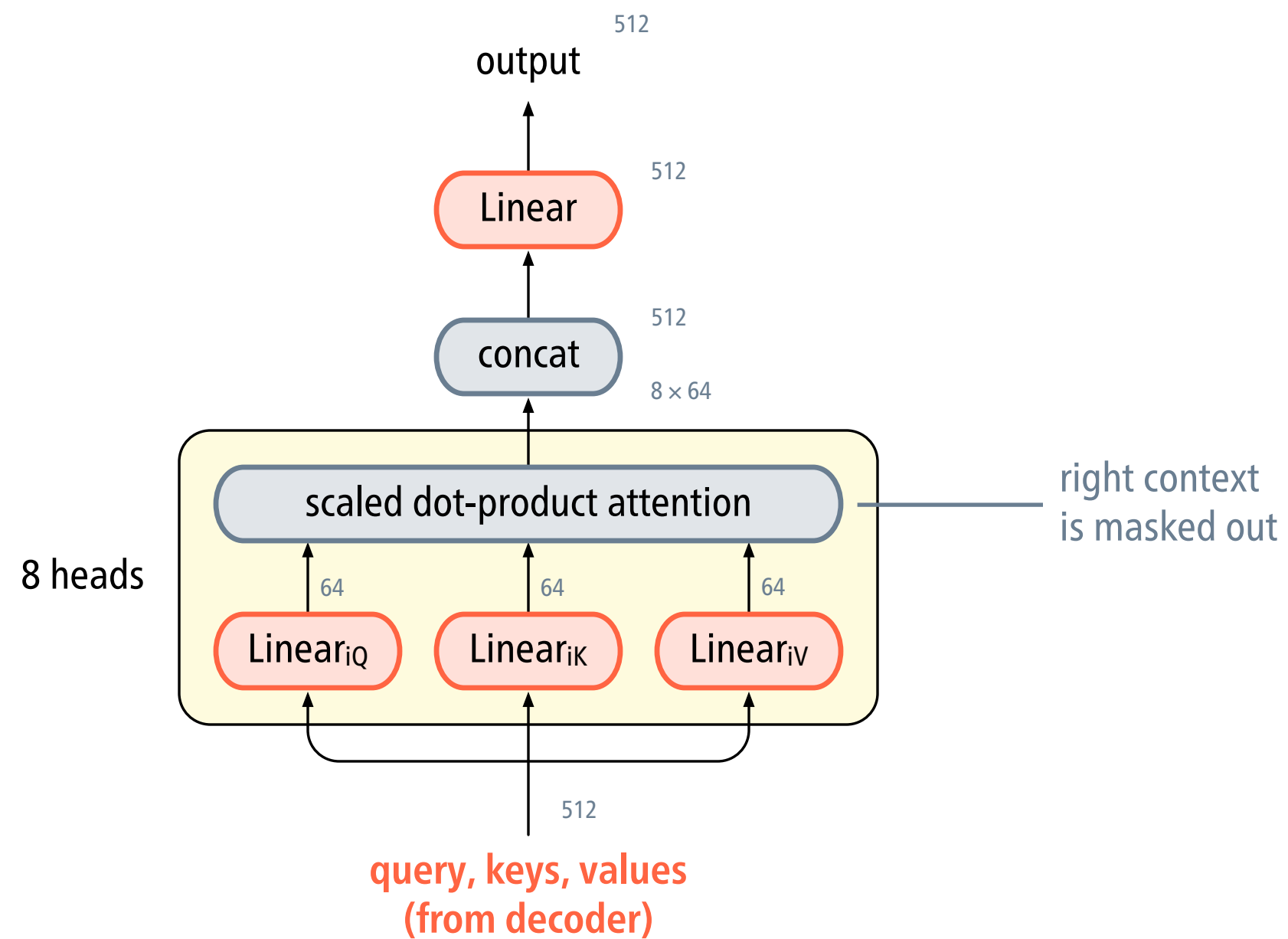

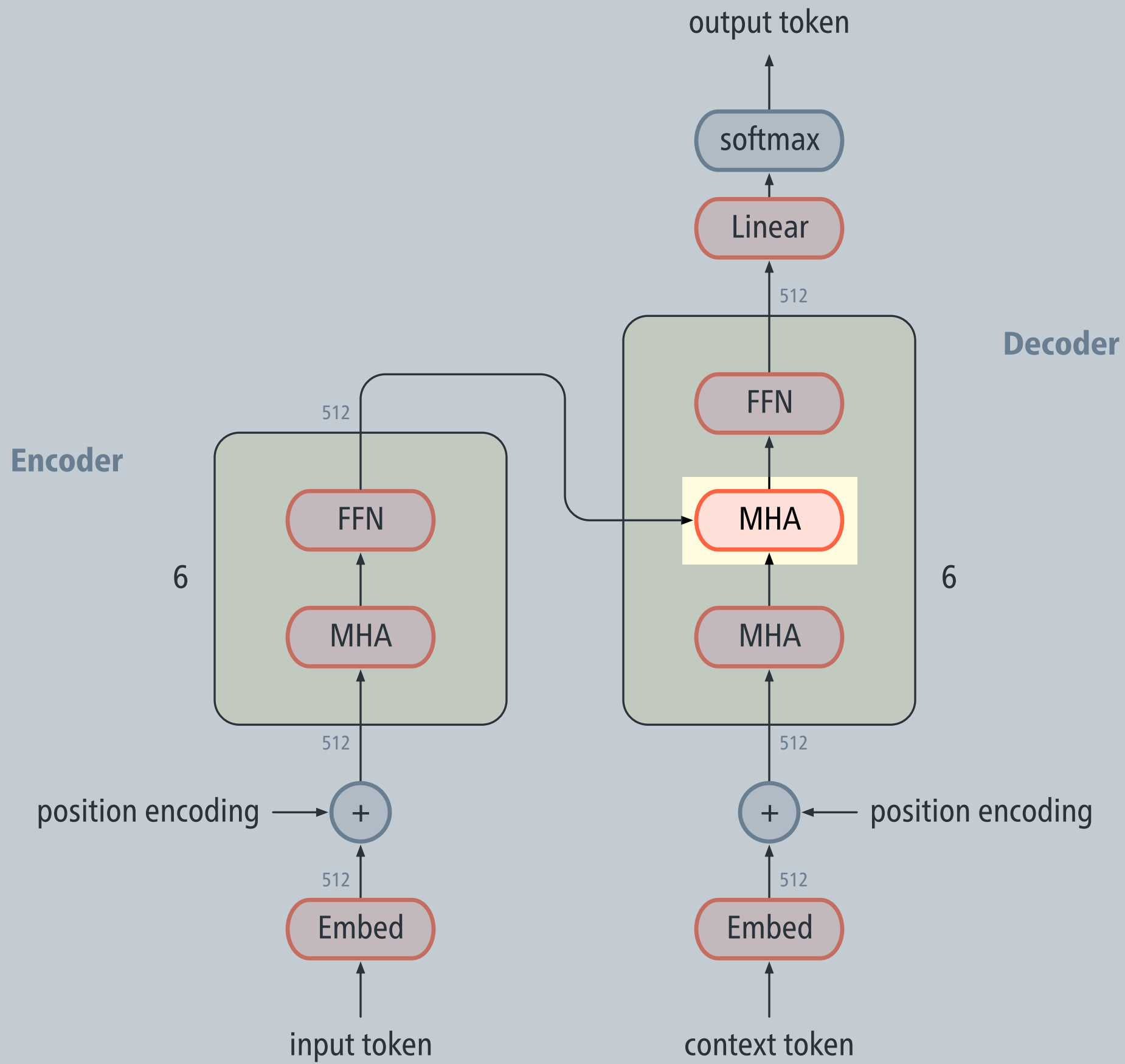

# Cross-attention

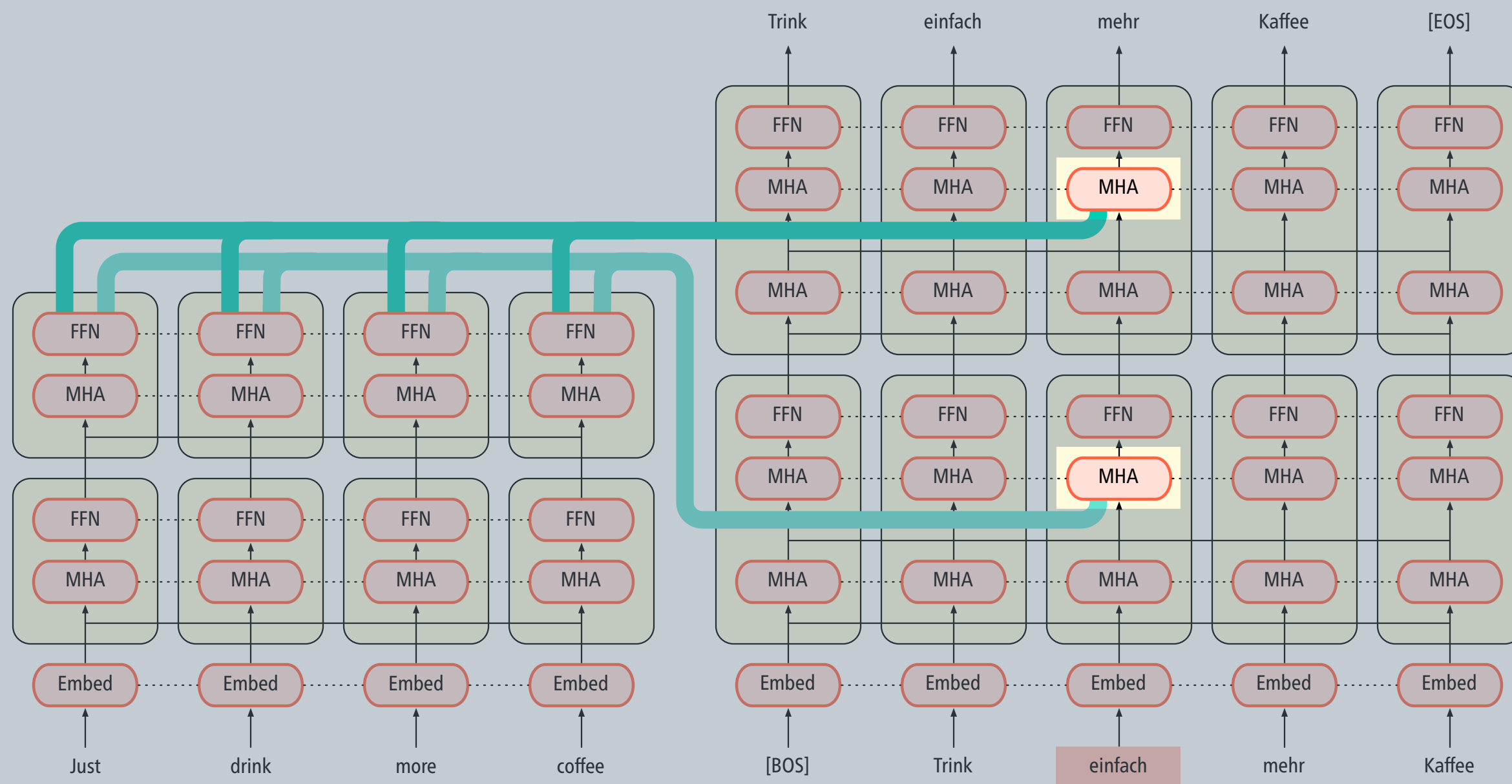

# Cross-attention

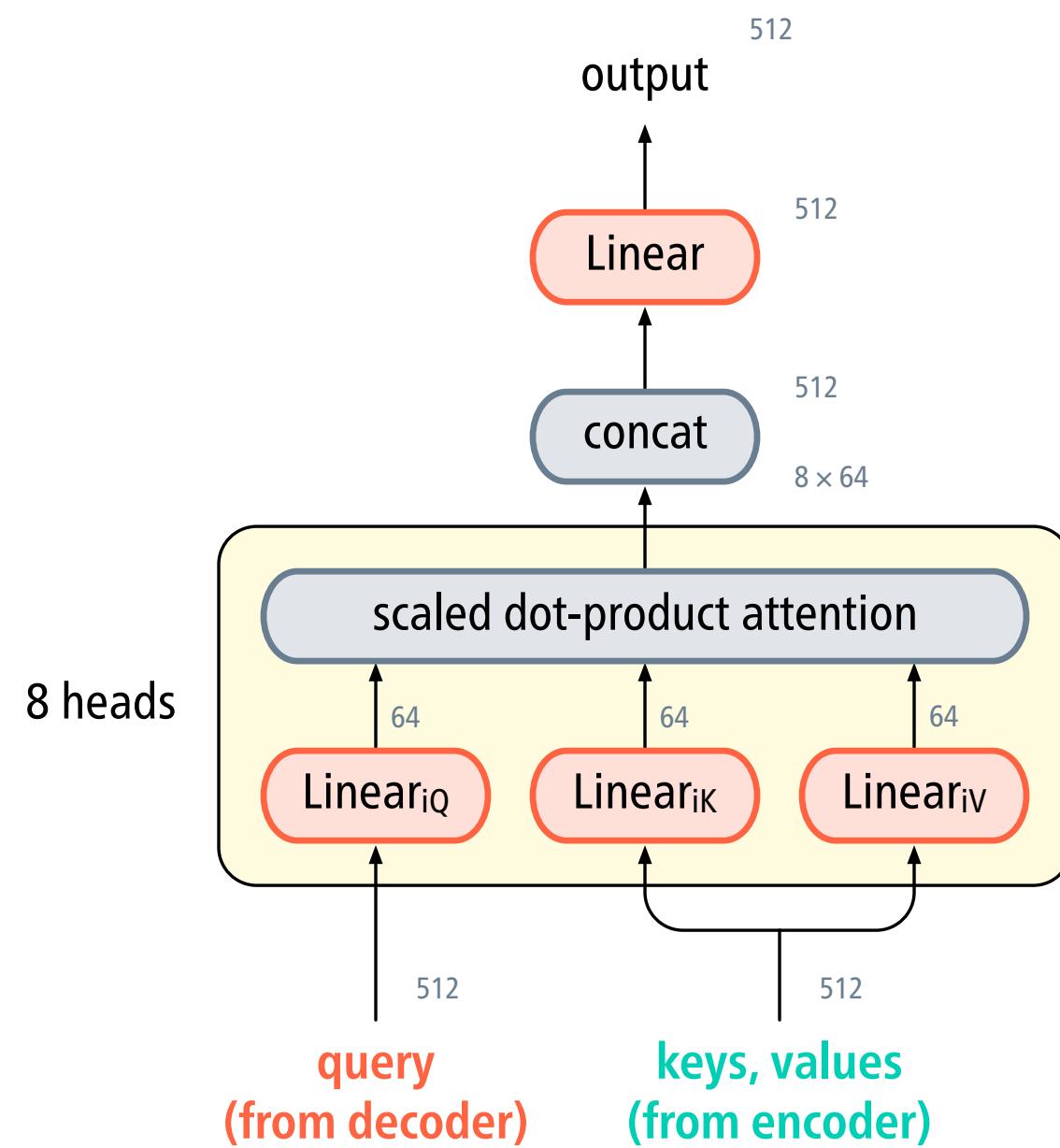

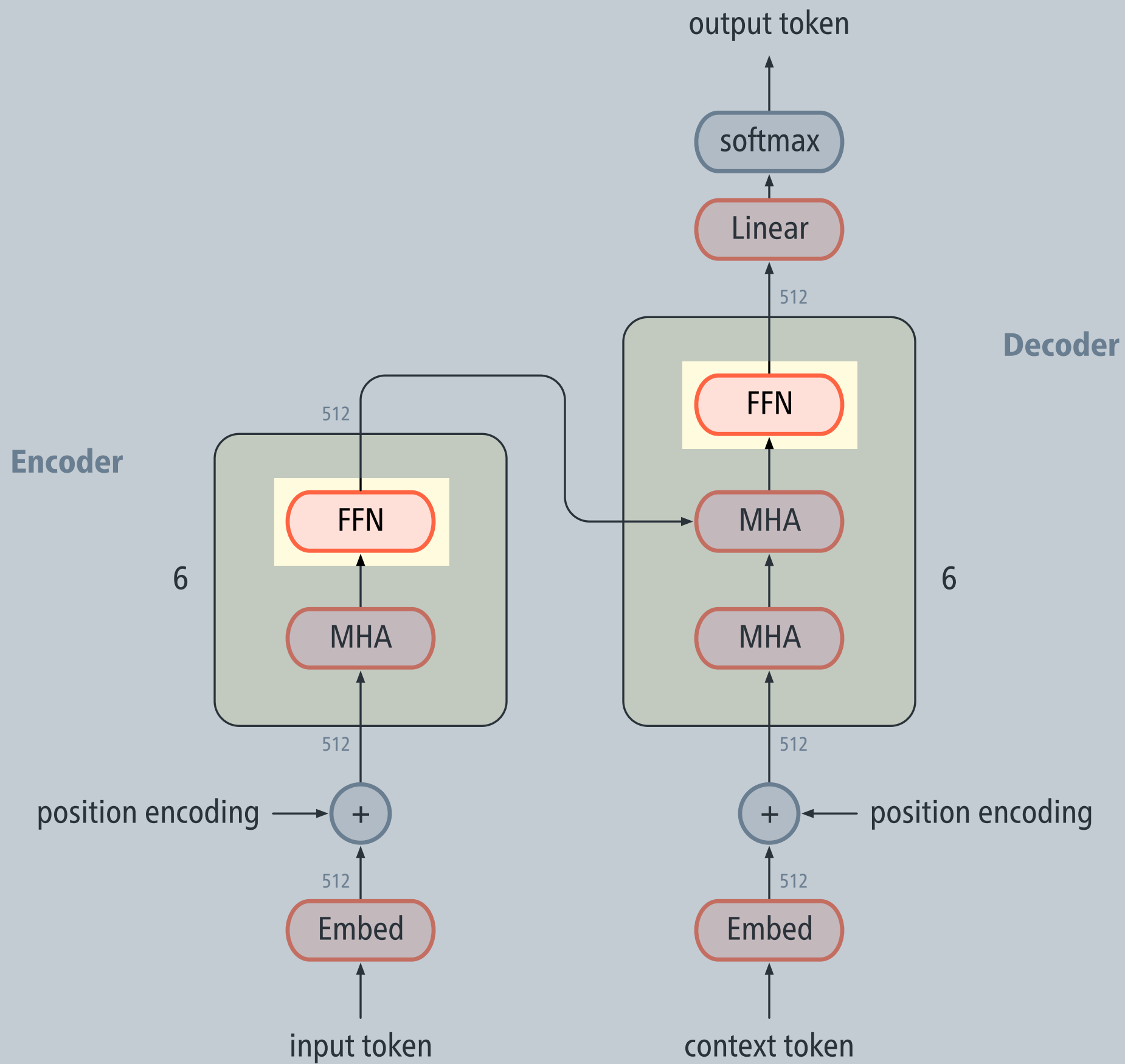

# Position-wise feed-forward network

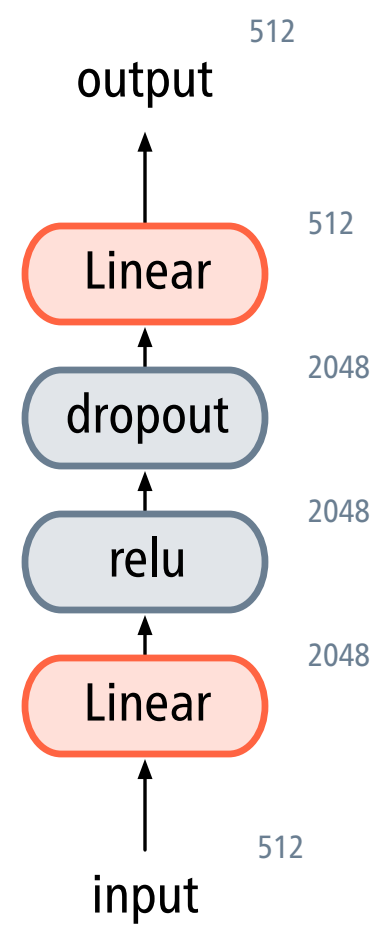

Parameters are shared across positions, but not across blocks.



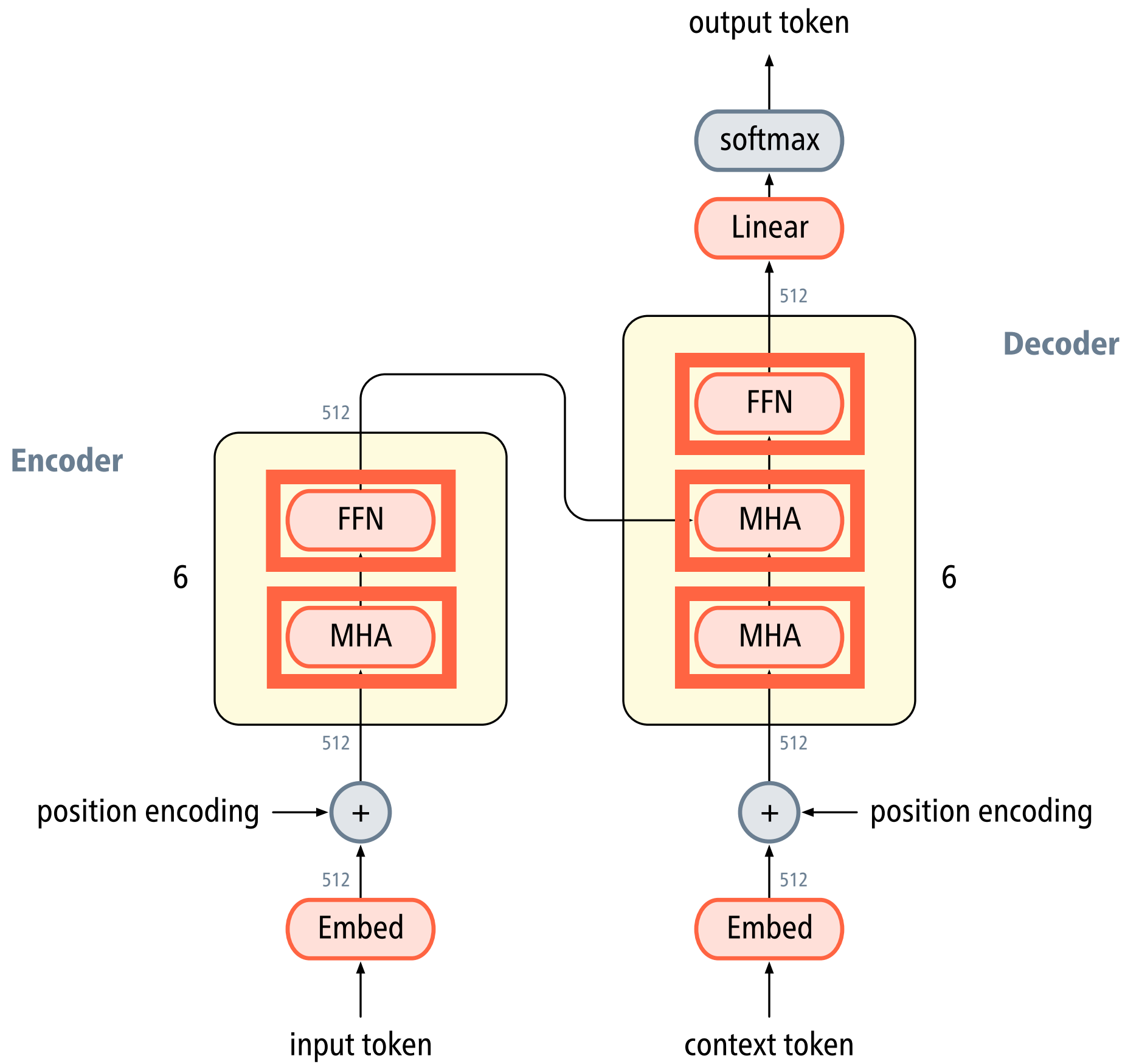

# Normalise-and-add wrapper

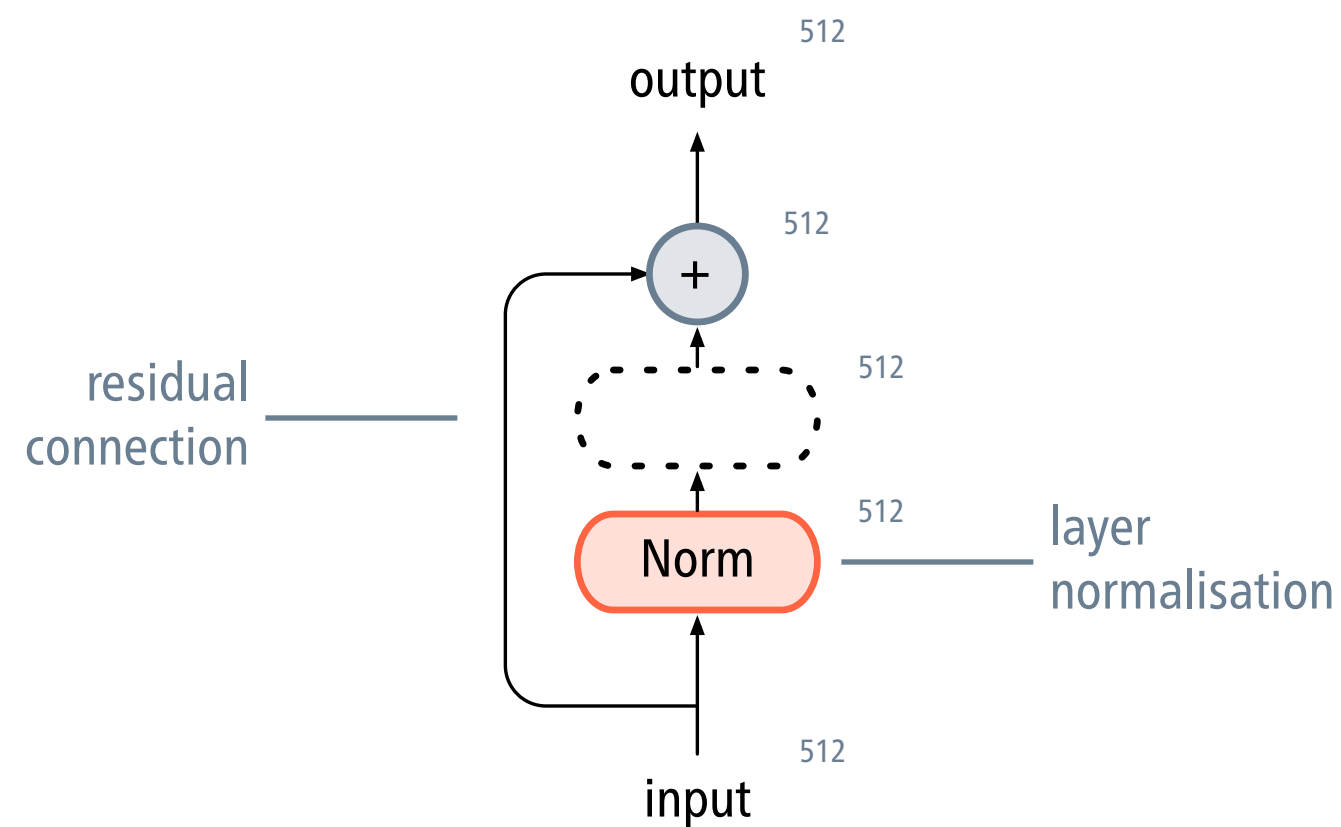

$$y = \frac{\mathbf{g}}{\sigma + \epsilon} \odot (\mathbf{x} - \mu) + \mathbf{b}$$

gain parameter  $\mathbf{g}$       bias parameter  $\mathbf{b}$

$$\mu = \frac{1}{|\mathbf{x}|} \sum_{i=1}^{|\mathbf{x}|} x_i$$

$$\sigma = \sqrt{\frac{1}{|\mathbf{x}|} \sum_{i=1}^{|\mathbf{x}|} (x_i - \mu)^2}$$

# Further details

- Token representations are defined on word pieces computed using byte-pair encoding.
- Embeddings are augmented by position encodings.  
approximate encoding of absolute positions
- Training the model uses several tricks related to batching, masking, loss, and regularisation.  
for details and PyTorch code, see the [‘Annotated Transformer’](#)

# Translation performance

	BLEU	FLOPs
GNMT + RL (Wu et al., 2016)	39.92	$1.4 \cdot 10^{20}$
ConvS2S (Gehring et al., 2017)	40.46	$1.5 \cdot 10^{20}$
MoE (Shazeer et al., 2017)	40.56	$1.2 \cdot 10^{20}$
Transformer (big model)	41.80	$2.4 \cdot 10^{19}$

BLEU score and training cost (FLOPs) on the English-to-French newstest2014 test data | [Vaswani et al. \(2017\)](#)